

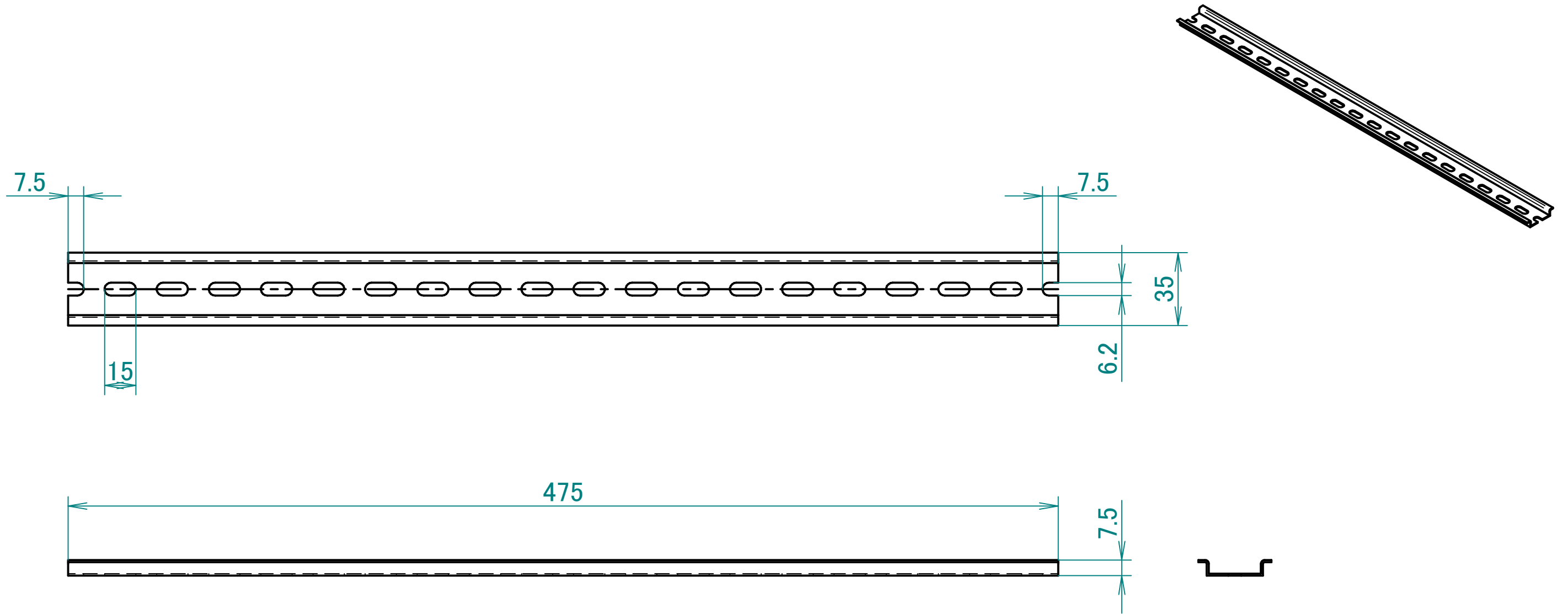

REVISION HISTORY

REV	DESCRIPTION	DATE	APPROVED



	NAME	DATE			
DRAWN	CZALCQ	08/19/21			
CHECKED					
ENG APPR					
MGR APPR			TITLE NS 35 /7.5 PERF 475MM/A		
UNLESS OTHERWISE SPECIFIED DIMENSIONS ARE IN MILLIMETERS ANGLES ±X.X° 2 PL ±X.XX 3 PL ±X.XXX			SIZE A3	DWG NO 1341697	REV 1
			FILE NAME: [1341697] NS 35 _7.5 PERF 475MM_A.dft		
SCALE:		WEIGHT:	SHEET 1 OF 1		