

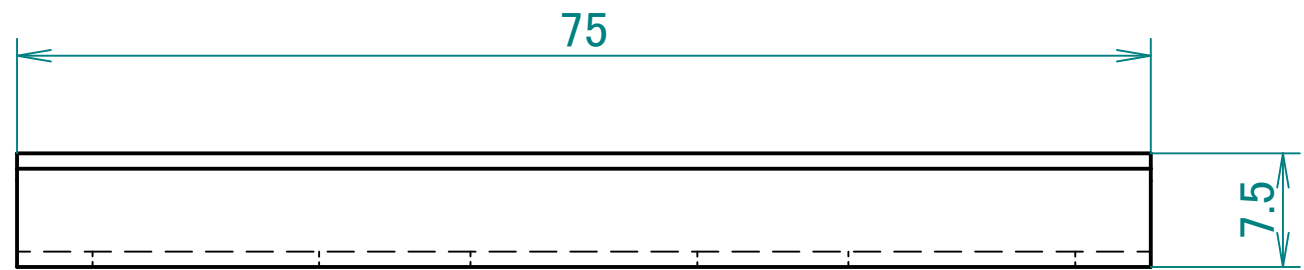

REVISION HISTORY			
REV	DESCRIPTION	DATE	APPROVED

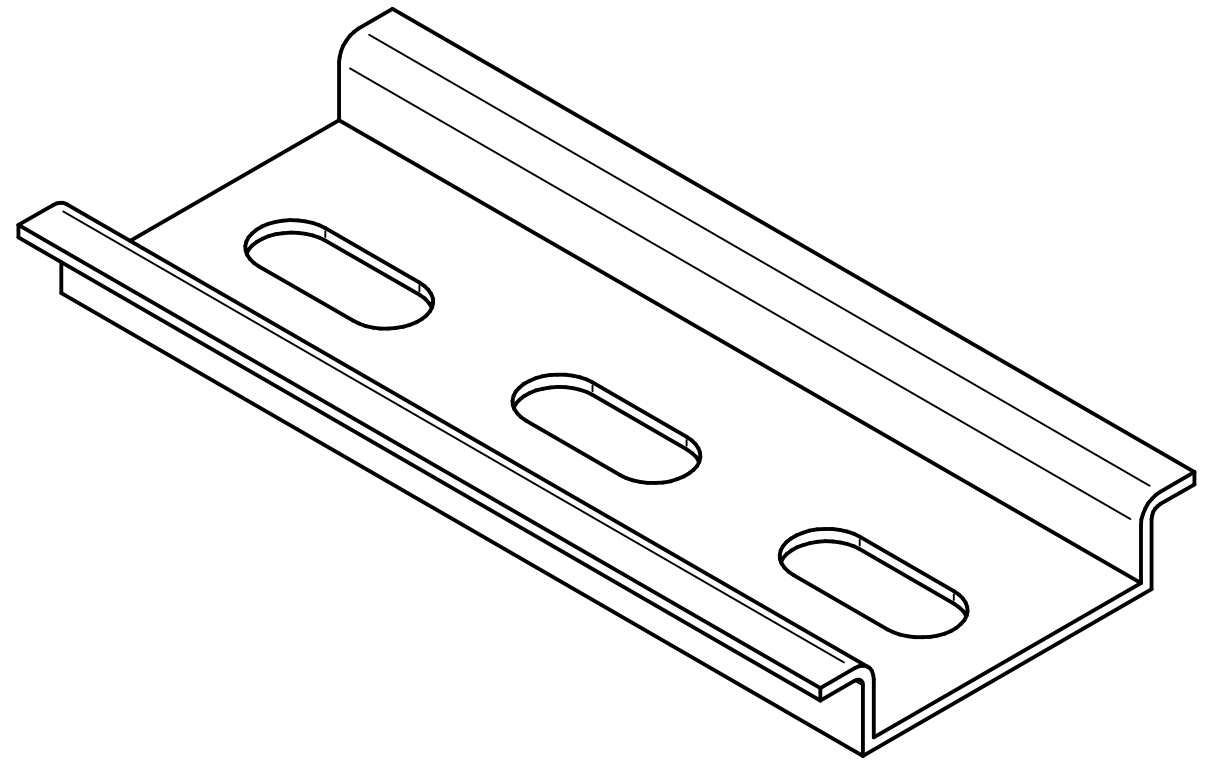
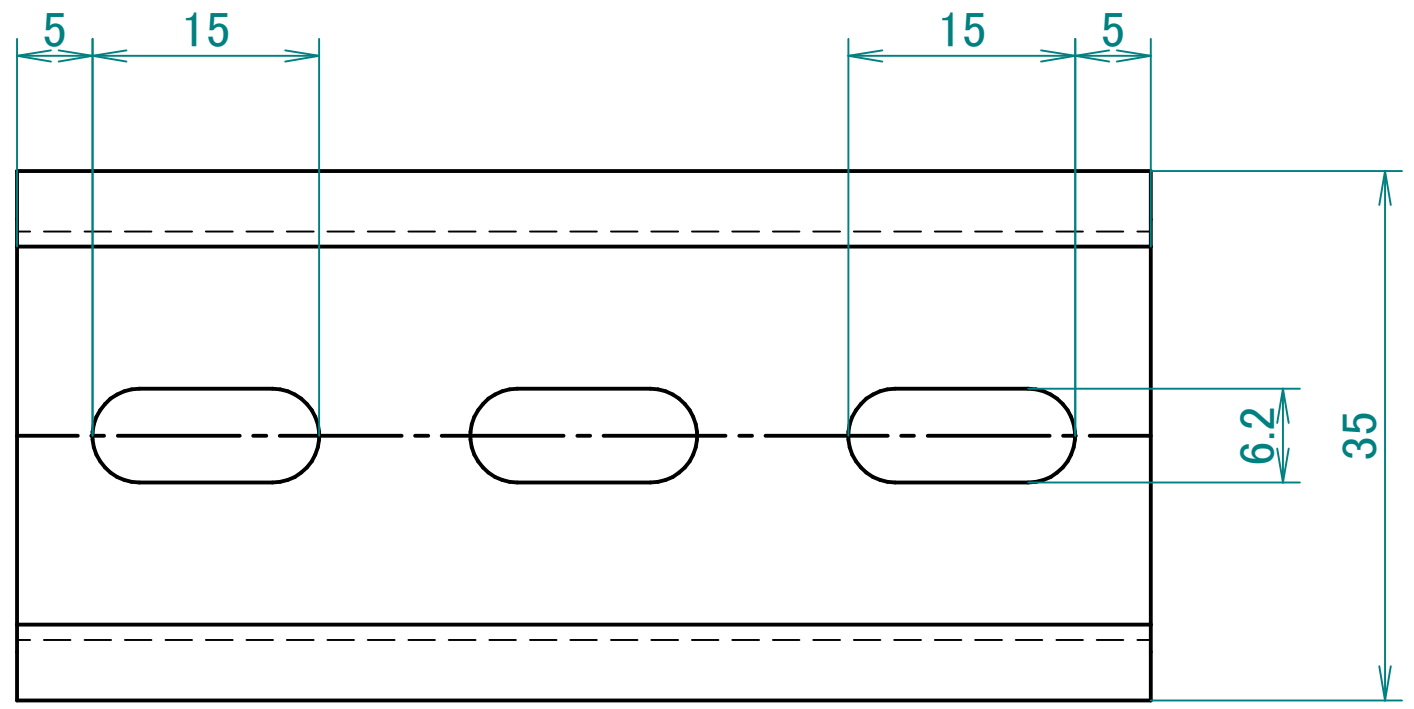

	NAME	DATE			
DRAWN	CZALCQ	08/19/21			
CHECKED					
ENG APPR					
MGR APPR			TITLE NS 35 /7.5 PERF 75MM/Z		
UNLESS OTHERWISE SPECIFIED DIMENSIONS ARE IN MILLIMETERS ANGLES ±X.X° 2 PL ±X.XX 3 PL ±X.XXX			SIZE A3	DWG NO 1341604	REV 1
			FILE NAME: [1341604] NS 35 _7.5 PERF 75MM_Z.dft		
			SCALE:	WEIGHT:	SHEET 1 OF 1